

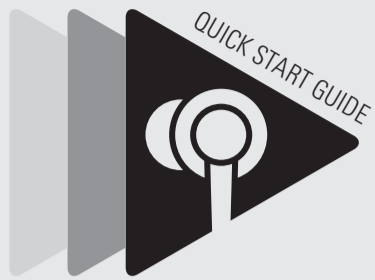

audio-technica



ATH-SPORT50BT

Check

- Headphones
- Eartips (XS, S, M, L)
- Ridged eartips (S, M, L)
- USB charging cable
- Pouch
- Quick start guide (this leaflet)
- Caution guide

Wear

Freely adjust the ear hangers to fit your ears

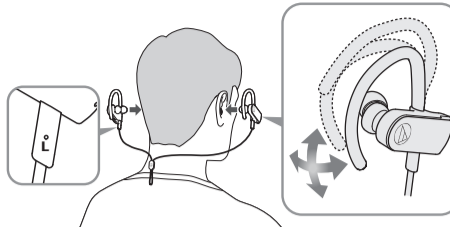

Pairing

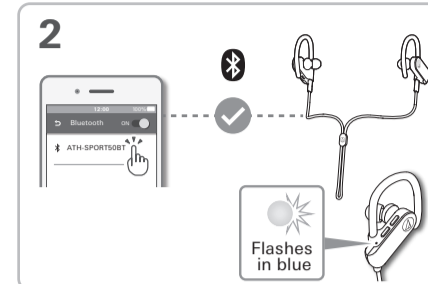
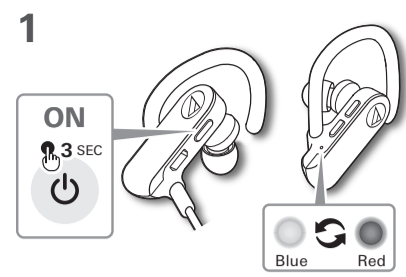

Music

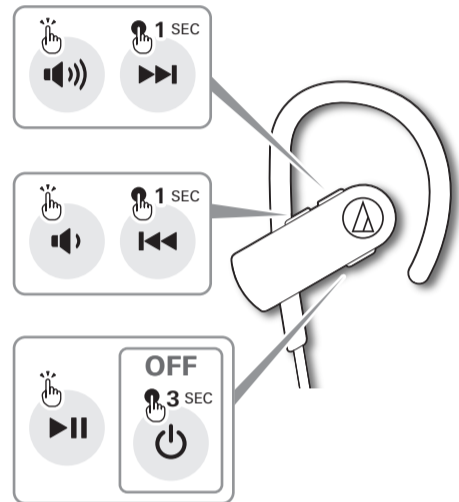

Phone

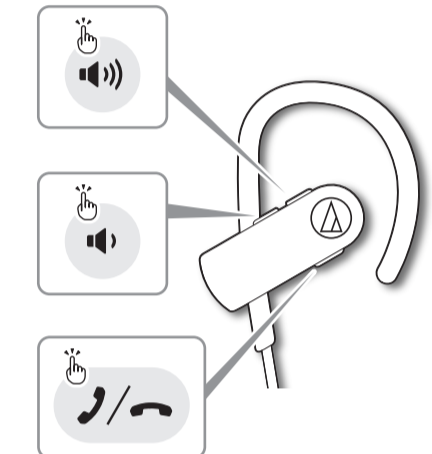

Charge

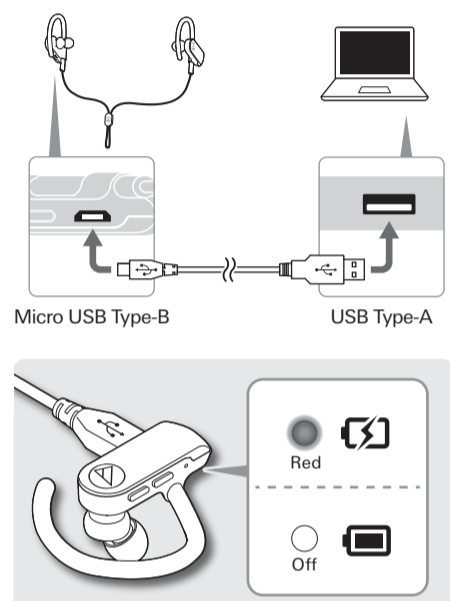

Help

For more information on how to use this product, visit the Audio-Technica website at the URL listed below and contained in the QR code.



www.audio-technica.com

The Bluetooth word mark and logos are owned by Bluetooth SIG, Inc. and any use of such marks by Audio-Technica Corporation is under license. All other trademarks are property of their respective owners.

Audio-Technica Corporation
2-46-1 Nishi-naruse, Machida, Tokyo 194-8666, Japan
www.audio-technica.co.jp ver1 2017.10.01
©2018 Audio-Technica Corporation 132313340-01-02 ver2 2018.03.01

Français / Deutsch / Italiano

Contrôler / Prüfen / Controllo

- Écouteur / Kopfhörer / Cuffie
- Embout (XS, S, M, L) / Kopfhöreraufsätze (XS, S, M, L) / Copriauricolari (XS, S, M, L)
- Embouts striés (S, M, L) / Gerippte Kopfhöreraufsätze (S, M, L) / Auricolari a cresta (S, M, L)
- Câble de recharge USB / USB-Ladekabel / Cavo per la carica USB
- Pochette de protection / Tasche / Sacca
- Guide de prise en main (ce dépliant) / Kurzanleitung (dieses Blatt) / Guida rapida (questo opuscolo)
- Guide de mise en garde / Sicherheitsanweisungen / Guida precauzionale

Porter / Tragen / Come indossare

Ajustez librement les contours d'oreille pour les adapter à vos oreilles

Justieren Sie die Ohrbügel, damit sie gut am Ohr sitzen

Regolare gli archetti a piacimento in modo da adattarli alle orecchie

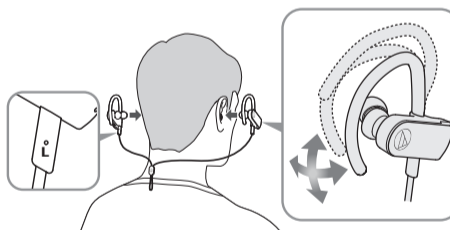

Appairage / Paarung / Associazione

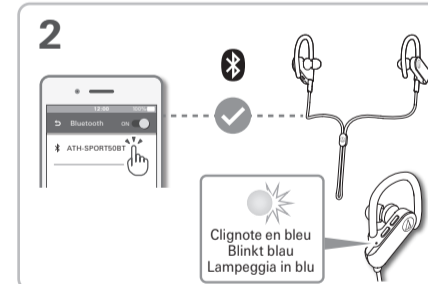
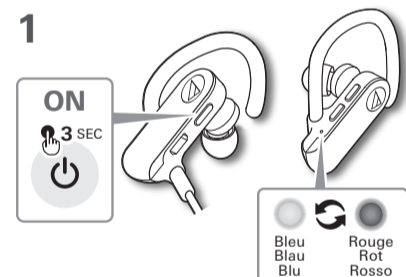

Musique / Musik / Musica

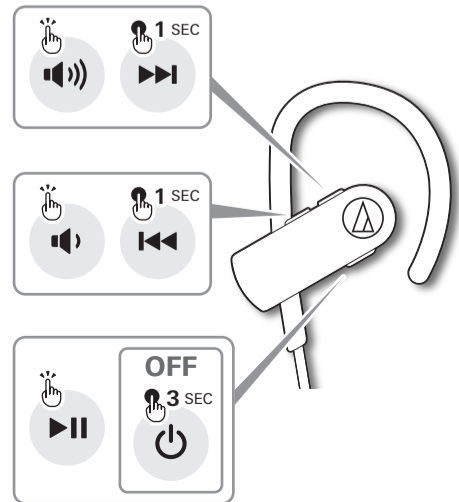

Téléphone / Handy / Telefono

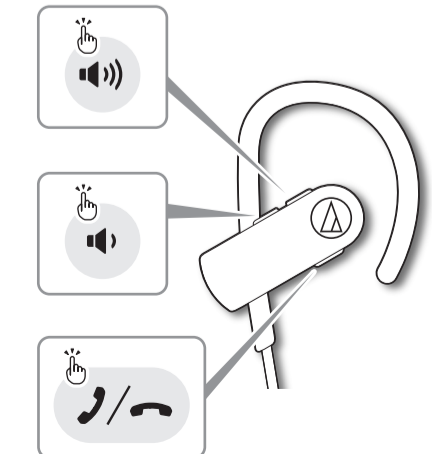

Charge / Laden / Carica

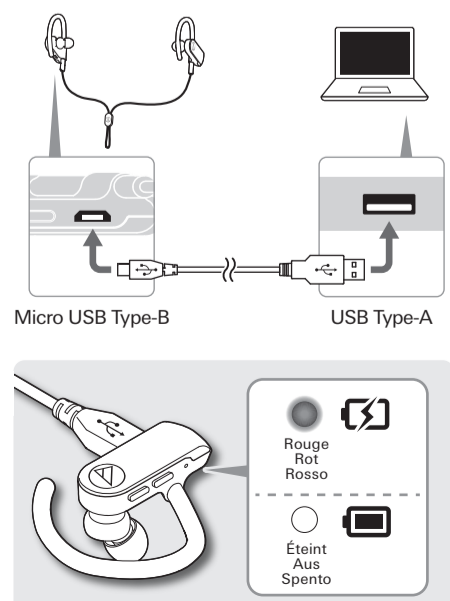

Aide / Hilfe / Guida

Pour plus d'information sur les modalités d'utilisation de ce produit, rendez-vous sur le site Web Audio-Technica à l'URL indiquée ci-après et contenue dans le code QR.

Für weitere Informationen zur Nutzung dieses Produkts besuchen Sie die Audio-Technica-Website unter der unten angeführten und der im QR-Code enthaltenen URL.

Per maggiori informazioni su come utilizzare questo prodotto, consultare il sito di Audio-Technica all'URL indicato di seguito e incluso nel codice QR.



www.audio-technica.com

La marque verbale et les logos Bluetooth sont détenus par Bluetooth SIG, Inc. et ces marques sont utilisées sous licence par Audio-Technica Corporation. Toutes les autres marques de commerce sont la propriété de leurs détenteurs respectifs.

Die Bluetooth-Wortmarke und -Logos sind Eigentum von Bluetooth SIG, Inc., und die Nutzung dieser Marken durch Audio-Technica Corporation erfolgt unter Lizenz. Alle anderen Markenzeichen sind Eigentum der jeweiligen Inhaber.

Il marchio e i logo del termine Bluetooth sono di proprietà di Bluetooth SIG, Inc., e qualsiasi utilizzo di tali marchi da parte di Audio-Technica Corporation è soggetto a licenza. Tutti gli altri marchi sono di proprietà dei rispettivi proprietari.

✓ Comprobar / Verificação / Проверка



- Auriculares / Fones de ouvido / Наушники
- Puntas de audífono (XS, S, M, L) / Ponteiros (PP, P, M, G) / Насадки (размеры XS, S, M, L)
- Puntas de audífono estriadas (S, M, L) / Ponteiros sulcadas (P, M, G) / Рельефные ушные вкладыши (размеры S, M, L)
- Cable de carga USB / Cabo de carga USB / USB-кабель для зарядки
- Bolsa / Bolsa / Сумка
- Guía de inicio rápido (este folleto) / Guia rápida (este folheto) / Краткое руководство пользователя (этот буклет)
- Guía de precauciones / Guia de precauções de segurança / Руководство по мерам предосторожности

Colocación / Uso / Надевание

Ajuste libremente los ganchos para adaptarlos a sus orejas

Ajuste livremente os suportes de orelha para que se encaixem em suas orelhas

С легкостью регулируйте положение заушин по форме ушей

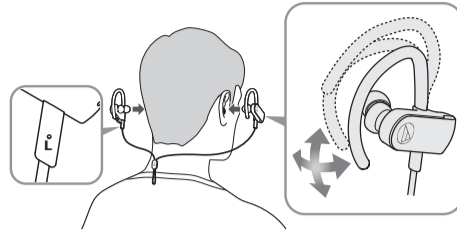

Emparejamiento / Emparelamento / Сопряжение

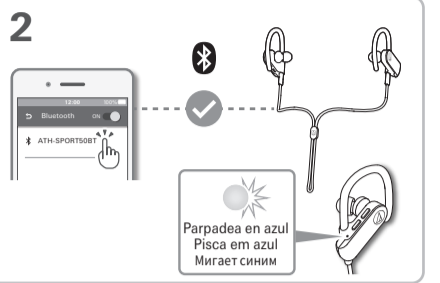
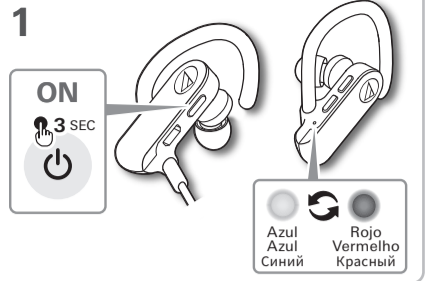

Música / Música / Музыка

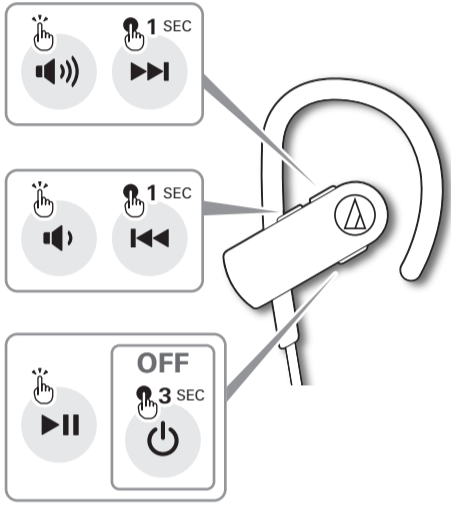

Teléfono / Telefone / Телефон

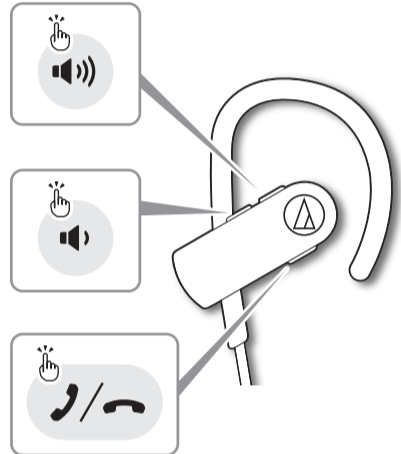

Carga / Carregar / Заряд

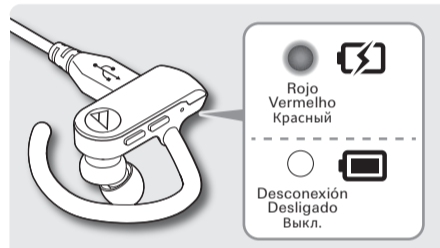
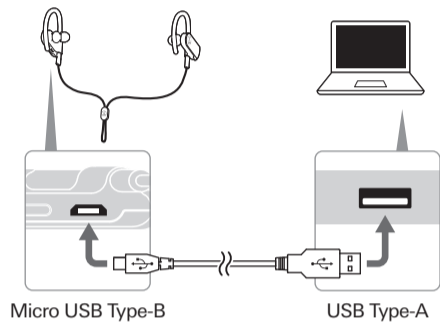

Ayuda / Ajuda / Справка

Para obtener más información sobre cómo usar este producto, visite el sitio web de Audio-Technica en la URL mostrada a continuación e incluida en el código QR.

Para obter mais informações sobre como usar este produto, visite o site da Audio-Technica no endereço listado abaixo e contido no código QR.

Для получения дополнительной информации по использованию этого изделия посетите веб-сайт компании Audio-Technica по адресу, указанному ниже, а также зашифрованному в QR-коде.



www.audio-technica.com

• La palabra con la marca Bluetooth y los logotipos son propiedad de Bluetooth SIG, Inc., y Audio-Technica Corporation los utiliza bajo licencia. El resto de marcas comerciales son propiedad de sus respectivos propietarios.

• A marca nominativa e os logotipos Bluetooth são de propriedade da Bluetooth SIG, Inc. e qualquer uso dessas marcas pela Audio-Technica Corporation é feito sob licença. Todas as outras marcas comerciais são de propriedade de seus respectivos proprietários.

• Словесный знак и логотипы Bluetooth принадлежат Bluetooth SIG, Inc. Любое использование таких знаков компаний Audio-Technica Corporation осуществляется в соответствии с лицензией. Все остальные товарные знаки являются собственностью соответствующих владельцев.

✓ 检查 / 檢查 / 점검



- 耳机 / 耳機 / 헤드폰
- 耳套 (XS、S、M、L) / 耳塞 (XS、S、M、L) / 이어팁 (XS, S, M, L)
- 脊线耳套 (S、M、L) / 脊線耳塞 (S、M、L) / 굴곡 이어팁 (S, M, L)
- USB充电线 / USB充電線 / USB 충전 케이블
- 收纳袋 / 攜存袋 / 파우치
- 快速入门指南 (本说明书) / 快速入門指南 (本手冊) / 빠른 시작 가이드 (본 소책자)
- 注意事项指南 / 注意事項 / 주의사항 안내

佩戴 / 佩戴 / 마모

自由调节耳挂以贴合耳朵

自由調整耳掛以貼合耳朵

귀에 맞게 귀걸이를 자유롭게 조정

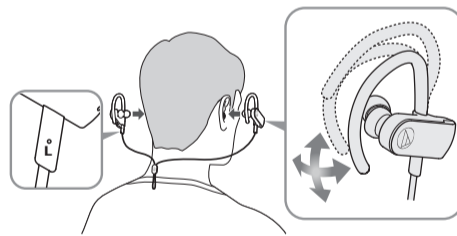

配对 / 配對 / 페어링

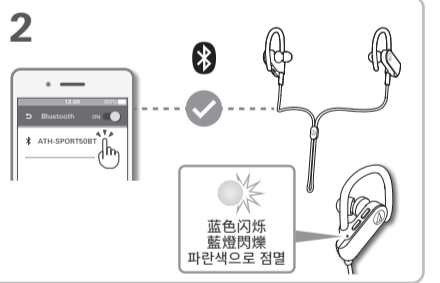
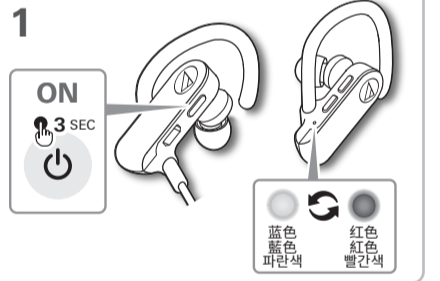

音乐 / 音樂 / 음악

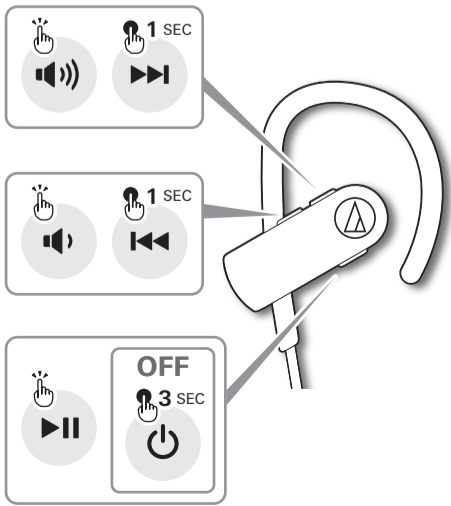

电话 / 電話 / 전화

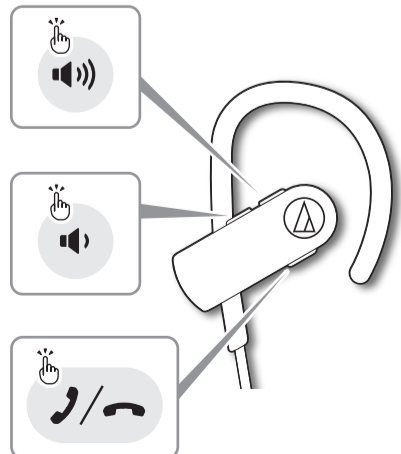

充电 / 充電 / 충전

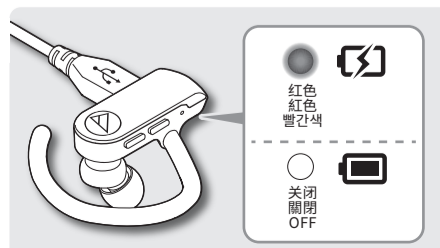
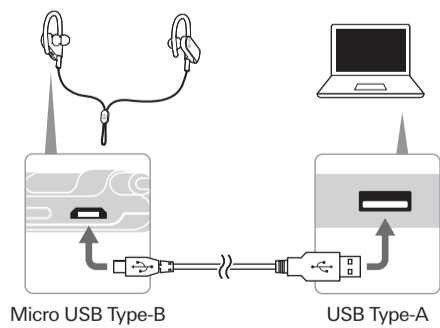

帮助 / 說明 / 도움말

更多关于如何使用本产品的信息，请通过下列网址或扫描二维码访问“鐵三角”网站。

欲獲得本產品的詳細使用方式，請掃描下方 QR code 或直接透過網址連接至「鐵三角」網站。

본 제품의 사용법에 관한 자세한 사항은 아래의 URL과 QR 코드에 있는 Audio-Technica 웹사이트에서 확인할 수 있습니다.



www.audio-technica.com

• 藍牙® 文字商標和徽標歸藍牙技術聯盟 (Bluetooth SIG, Inc.) 所有，「鐵三角」公司已獲得其使用授權。所有其他商標均歸其各自所有者所有。

• 藍牙® 文字標記和標識屬 Bluetooth SIG, Inc. 所有，「鐵三角」公司已取得該標記之使用許可。所有其他商標均為其各自所有者的財產。

• Bluetooth® 단어 및 로고는 Bluetooth SIG, Inc. 의 소유이며 Audio-Technica Corporation은 이러한 마크에 대한 사용 허가를 받았습니다. 기타 모든 상표는 해당 소유주의 자산입니다.