



engineeredsound®



Thank you for purchasing this product. Before using the product, read through the user manual to ensure that you will use the product correctly. Please keep this manual for future reference.

Features

- Designed for surface-mount applications such as conferencing, recording, monitoring and other demanding sound pickup applications
- Logic I/O capability permits control of remote devices from mic's touch-sensitive capacitive-type user switch
- Highly visible two-state RGB LED ring (7 selectable colors + OFF) indicates mute status
- Low-profile element provides uniform omnidirectional polar pattern with 360° acceptance angle
- Mounts unobtrusively in tabletops and panels
- Self-contained power module with XLRM-type output connector
- Rugged all-metal case with a two-layer perforated grille
- Rubber Isolators provide mechanical dampening of mounting-surface vibration
- Requires 11V to 52V DC phantom power
- UniGuard® RFI-shielding technology offers outstanding rejection of radio frequency interference (RFI)

Description

This phantom-powered omnidirectional condenser boundary microphone features a 5-pin XLR output connector with a touch-sensitive capacitive-type user switch for enhanced control in conference and boardroom installations. Not only can the switch be configured to toggle between mute and live audio, but, with the microphone's external contact closure, it can also be set up to trigger an external device, such as a camera or the room's lighting.

Designed for clear, highly intelligible conferencing, recording, monitoring and other demanding sound pickup applications, the ES9450/FM5 mounts unobtrusively in tabletops or panels, but includes a highly visible two-state RGB LED ring (7 selectable colors + OFF) to indicate mute status.

The microphone's omnidirectional polar pattern provides 360° coverage. A rugged all-metal case with a two-layer steel mesh grille protects the microphone element, while our UniGuard® RFI-shielding technology provides outstanding rejection of radio frequency interference (RFI).

The ES9450/FM5 is equipped with a self-contained power module, eliminating the need for an external one, and comes with a pair of rubber isolators for optional mechanical isolation from the mounting surface.

Avoid leaving the microphone in the open sun or in areas where temperatures exceed 43°C for extended periods. Extremely high humidity should also be avoided.

Safety precaution

Although this product was designed to be used safely, failing to use it correctly may result in an accident. To ensure safety, observe all warnings and cautions while using the product.

Cautions for the product

- Do not subject the product to strong impact to avoid malfunction.
- Do not disassemble, modify or attempt to repair the product.
- Do not handle the product with wet hands to avoid electric shock or injury.
- Do not store the product under direct sunlight, near heating devices or in a hot, humid or dusty place.

Connection procedure

Connect the output terminals of the microphone to a device that has a microphone input (balanced input) compatible with a phantom power supply. The output connector is an XLRM-type with polarity as shown in the figure below.

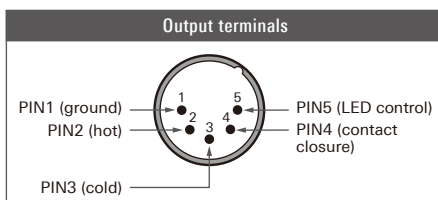

This product requires 48V DC phantom power.

Specifications

Element	Fixed-charge back plate, permanently polarized condenser
Polar pattern	Omnidirectional
Frequency response	60 - 15,000 Hz
Open circuit sensitivity	-33 dB re 1V at 1 Pa
Impedance	60 ohms
Maximum input sound level	130 dB SPL (1 kHz at 1% THD)
Dynamic range (typical)	109 dB (1 kHz at Max SPL)
Signal-to-noise ratio*	73 dB (1 kHz at 1 Pa, A-weighted)
Phantom power requirements	11-52 V DC, 6.8 mA
Weight	59 g
Dimensions	W 38 mm × D 48 mm × H 84.8 mm
Output connector	Integral 5-pin XLRM-type
Included accessories	Rubber isolator x 2, Nut

• 1 Pascal = 10 dynes/cm² = 10 microbars = 94 dB SPL

* Typical, A-weighted, using Audio Precision System One.

For product improvement, the product is subject to modification without notice.

Polar pattern

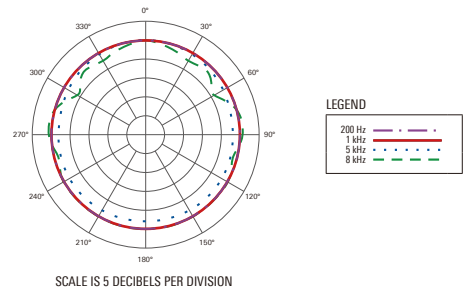

Frequency response

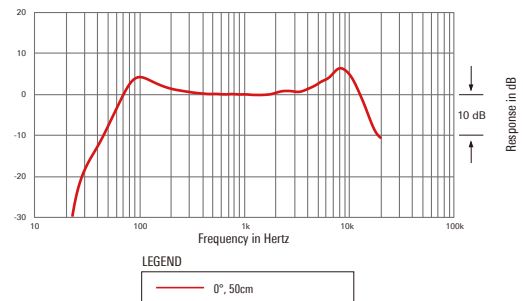

Dimensions

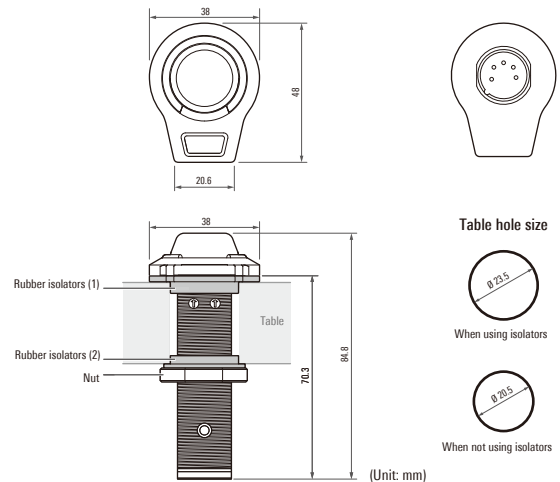

Audio-Technica Corporation
2-46-1 Nishi-naruse, Machida, Tokyo 194-8666, Japan
©2017 Audio-Technica Corporation

Global Support Contact: www.at-globalsupport.com



engineered sound®



感谢您购买本产品。在使用产品之前，请全文浏览本用户手册以确保您将正确地使用本产品。请妥善保存本手册，以供将来参考。

■ 特点

- 专为会议、录音、监听和其他要求苛刻的收音应用等表面安装应用而设计
- 逻辑输入/输出功能给予使用者通过电容感应式轻触开关来控制远程设备
- 高度可见的双态式 RGB LED 灯环（7种可选颜色 + 关灯）指示开启/静音状态
- 薄型元件提供均匀的全方向指向性，收音角度为360°
- 能牢固地安装在桌面和控制面板上
- 带 XLRM 型输出连接器的独立内置式供电模块
- 坚固的全金属外壳，配有两层穿孔保护网格
- 橡胶防震片可阻隔安装表面的机械式振动
- 使用 11V 至 52V 直流幻象电源
- UniGuard® RFI 屏蔽技术可有效地抑制射频干扰

■ 说明

ES9450/FM5 全指向性电容式界面话筒配备了5针 XLRM 型输出连接器和一个电容感应式轻触开关，可增强对会议室装置的控制。不仅可以将开关设置为在控制话筒静音和收音之间的切换，还可以通过话筒的接点闭合来触发外部设备，例如摄像头或房间的照明系统。

采用不显眼设计，可以安装在桌面或控制面板上，以提供最佳的隐蔽性，提供清晰而通透的收音，非常适合会议、录音、监听和其他要求苛刻的收音应用，而话筒顶部设有可见度高的双态式 RGB LED 灯环（7种可选颜色 + 关灯），能显示开启/静音状态。

话筒采用坚固的全金属外壳和两层穿孔保护网格，其全指向性模式提供了360°的收音角度，而话筒配有 UniGuard® RFI 屏蔽技术可以有效地抑制射频干扰。

ES9450/FM5 内置 XLRM 型输出连接器的独立供电模组，从而无需外部电源元件。话筒配备有一对橡胶防震垫片，用于阻隔安装表面的机械式振动。

把话筒暴露于高温中可能导致输出电平逐渐及永久性减弱，应避免将话筒留在日晒的地方或长时间置于温度超过43°C的地方，而极高湿度也应避免。

■ 安全预防措施

虽然本产品采用安全设计，但使用不当仍可能发生事故。为了确保安全，使用本产品时请注意全部警告和提醒。

■ 本产品注意事项

- 设切勿让本产品遭受强烈冲击，以避免发生故障。
- 屏切勿拆开、改装或尝试维修本产品。
- 独切勿用湿手握持本产品，以免触电或受伤。
- 小切勿将本产品存放在阳光直射的地方、加热装置附近或者炎热、潮湿或多尘的地方。

■ 连接步骤

将话筒的输出端子连接到具有兼容幻象电源的话筒输入（平衡输入）的设备。输出接口是 XLRM 型接口，其极性如下图所示。

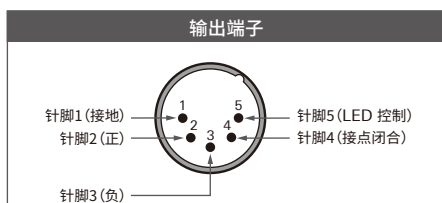

本产品使用直流 48V 幻象电源。

■ 规格

元件	固定充电背板,永久极化电容体
指向性	全指向性
频率响应	60 - 15,000 Hz
开路灵敏度	-33 dB (0dB = 1V/Pa, 1kHz)
阻抗	60 欧姆
最大输入声压级	130 dB SPL (1kHz 于 1% THD)
动态范围(典型)	109 dB (1kHz 于最大声压级)
信噪比*	73 dB (1kHz于1Pa, A计权)
幻象供电	直流 11-52V, 6.8mA 典型
重量	59 克
尺寸	高 84.8 毫米, 收音头宽 38 毫米 x 长 48 毫米
输出接口	内置 XLRM-5 针卡农公头
附带配件	橡胶防震垫片 x 2, 螺母

* 1 帕 = 10 达因 / 平方厘米 = 10 微巴 = 94 dB SPL
* 典型, A 计权, 使用 Audio Precision System One
因产品改进, 本产品会随时改装, 恕不另行通知。

■ 指向性

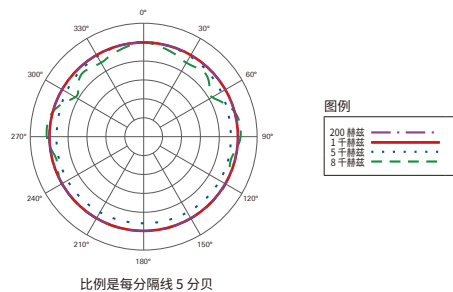

■ 频率响应

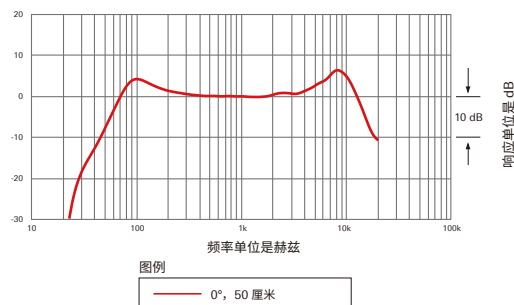

■ 尺寸

